

RM6

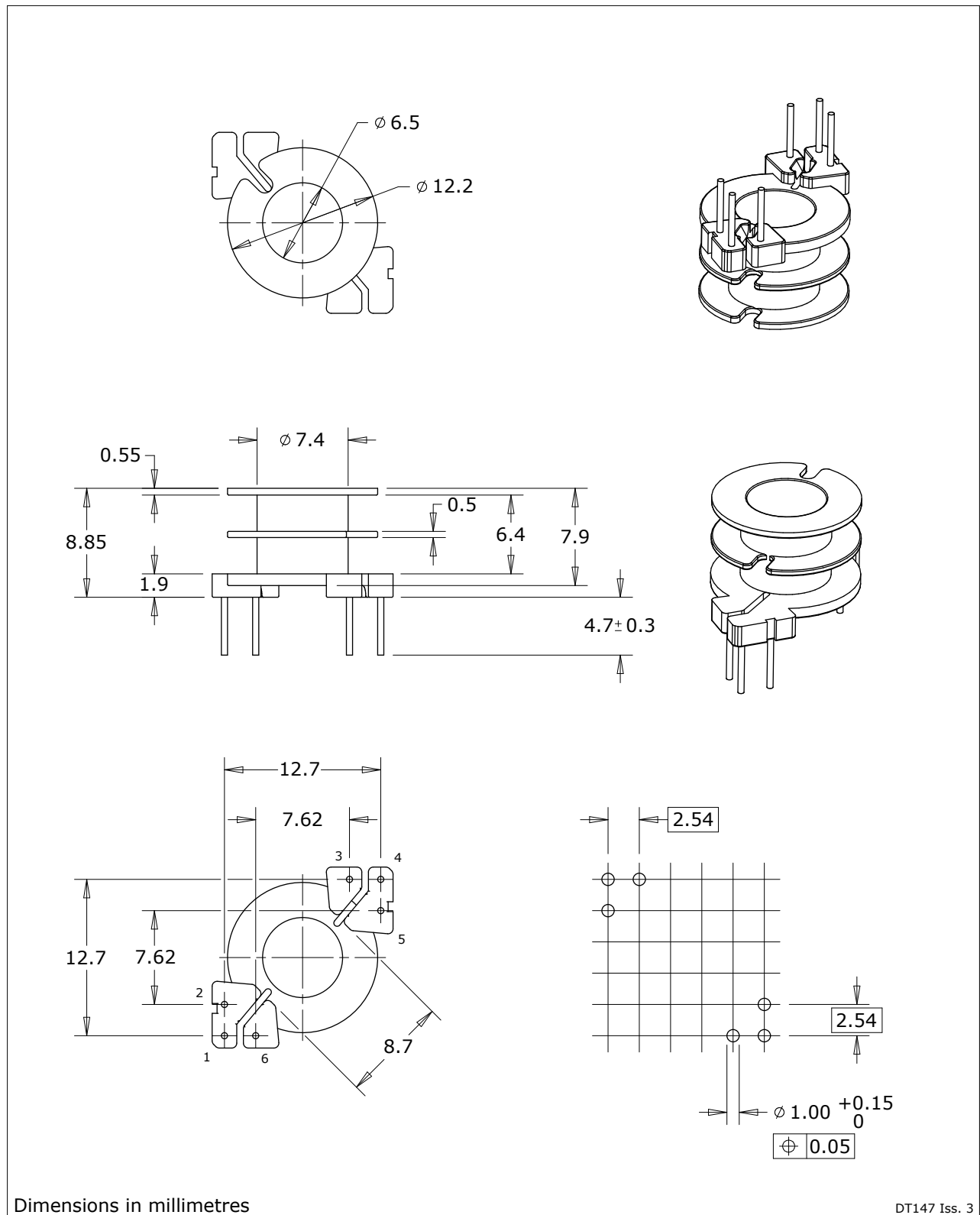

Coil Former	
Coil former material	Phenolformaldehyde (PF), glass reinforced, flame retardant in accordance with "UL 94V-0"; UL file number E41429 (M)
Resistance to soldering heat	"IEC 60068-2-20", Part 2, Test Tb, method 1B, 350 deg. C, 3.5 s
Pin material	0.50 Dia. copper clad steel wire (ASTM.B.227) - Tin (Sn) plated
Solderability	"IEC 60068-2-20", Part 2, Test Ta, method 1, 235 deg. C, 2 s
Pin pull out force	0.7 Kg Minimum
Part number	RM06V2S06IS-00